

Accenta/Optima

User Guide

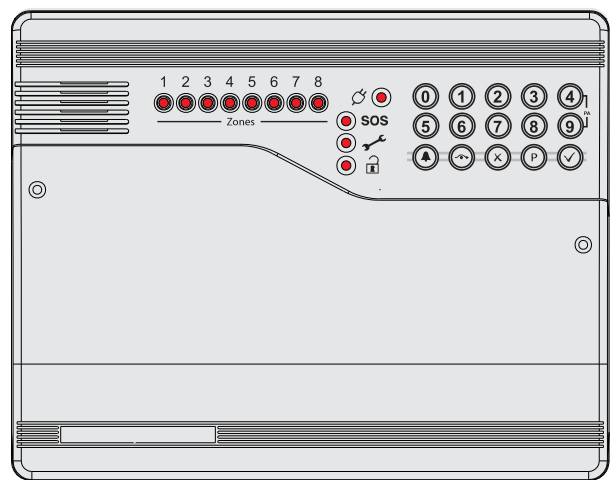
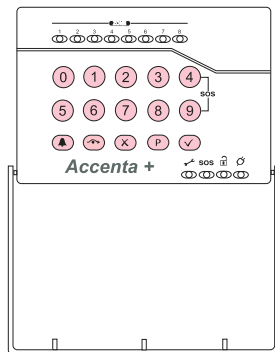
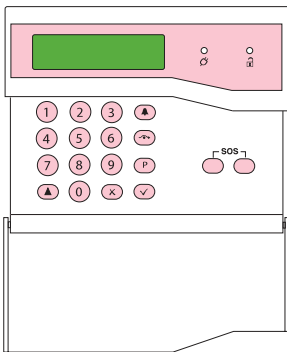

Servicing Organisation (Installer) name: _____

Telephone Number: _____

Date of Installation: _____

Account Number: _____

Contents

Introduction 1

Codes 1

Alarm System Operation 1

Personal Attack 1

Fire Zones 1

Power Indicator 1

Signalling Device 1

How to Set the System 2

How to Unset the System 3

How to Part Set the System 4

How to Silence an Alarm and Reset the System 5

How to Omit Zones 6

How to Quick Set the System 7

Single Key Setting 7

How to Set Up Chime Mode 8

How to Change the Language 9

Changing Codes Using User 1 10

Changing Codes Using User 2 11

How to Delete User Code 2 11

 To delete user code 2 using user code 1 12

 To delete user code 2 using user code 2 13

Duress Code 14

How to View the Event Log 15

How to Test Your Alarm system 16

 How to Test the Bell, Strobe and Internal Sounder 16

How to do a Walk Test 18

How to Set up the Time and Date 19

Introduction

This User Guide tells you how to operate your intruder alarm system. To simplify this User Guide we have assumed that the alarm system has been installed by a professional intruder alarm system installer (the installer), and that the system is operated in a “typical” way. Aspects of your system that are not “typical” will be described by your installer.

NOTE: If you have any questions about your intruder alarm system, then consult your installer, see contact details at the front of this User Guide.

Codes

To operate the alarm system you will need to use a code. A code is 4 digits long, and can be any number from 0000 to 9999. By default user code 1 is [0][1][2][3] but you should change this as soon as possible.

Alarm System Operation

This booklet describes three versions of the alarm system. The **Optima** version has the keypad and indicators on the main control panel. The **Accenta** version has the keypad and indicators on a small remote LCD or LED keypad. You operate the alarm system by pressing keys on the keypad and viewing the indicators. Both alarm systems work the same way. Both **Accenta** and **Optima** systems can be fitted with an optional remote keypad.



Personal Attack

If the installer has programmed personal attack on the keypads and if you are under threat, or are being attacked, you can activate the alarm by pressing the **4** and **9** keys at the same time on any LED keypad. You can also press the two keys marked **PA** on the remote LCD keypad. The alarm system will produce a loud alarm sound, and the external siren will be turned on.

Fire Zones

Zones 7 and 8 on your alarm system may have a Fire or Smoke detector connected to it. In the event of a fire the alarm system will produce a distinctive two-tone fire alarm sound, and the outside siren will pulse 2 seconds on, 2 seconds off. You should leave the premises immediately, and only re-enter when it is safe to do so. The alarm can be silenced by entering your code.

Power Indicator

The  indicator on the control panel or keypad will light whenever the mains power supply is present. If mains power fails then the  indicator will go out, but the system will run from its backup battery for several hours. If the  indicator goes out when mains power is present then a fault may have developed on your system and you should contact your installer.

Signalling Device

Your alarm system may have been fitted with a signalling device. This device uses the telephone line to send an alarm message to an Alarm Receiving Centre in the event of an alarm. The operator at the ARC may request the police to attend your premises.

How to Set the System

When you leave your premises you will need to set (or turn on) the intruder alarm system.

Before setting the system you should ensure that the premises have been completely vacated and that all doors and windows are closed. Ensure that pets do not have access to the protected areas as they can cause a false alarm.

NOTE: The Accenta Remote LED keypad is not shown. It will have the same indications as the Optima compact panel with built-in keypad.

NOTE: There will be no exit beeps if **Silent Timed** exit mode was programmed.

LCD Keypad: the  LED should be on. The screen shows the date and time:

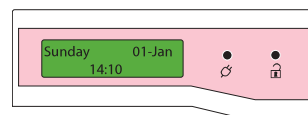

LED Keypad: the  LED should be on.

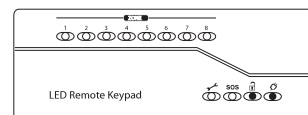



NOTE: You should wait until you hear that the exit beep has stopped before assuming that the system is set.

LCD Keypad:

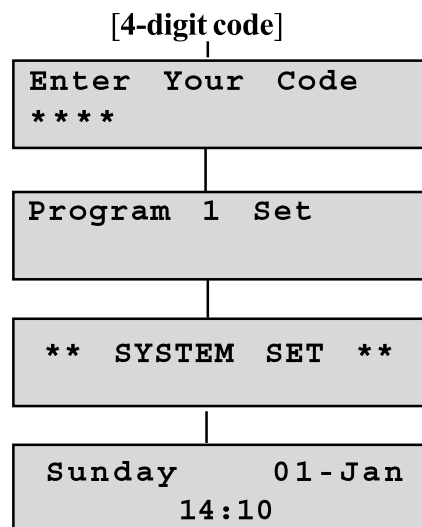
- Enter your 4-digit code (**0123** default) and check that the system is clear.
- The exit tone begins to sound and the display shows program 1 in process of setting.
- Leave the premises by the agreed exit route.
- The exit tone becomes rapid during the last 10 seconds and then stops when the system sets. The  LED goes off and **SYSTEM SET** appears on the screen
- After 30 seconds the date and time are displayed.



LED Keypad:

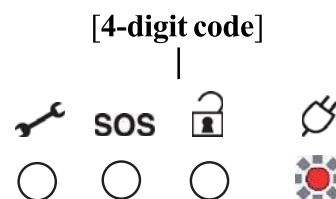

- The system is unset. The  and  LEDs are on.
- Enter your 4-digit code (**0123** default) and check that the system is clear (no zone LED's on).
- The exit tone begins to sound to indicate that the system is in the process of setting.
- Leave the premises by the agreed exit route.
- The exit tone becomes rapid during the last 10 seconds and then stops when the system sets. The  LED goes off.



How to Unset the System



When you enter your premises you need to unset (turn off) the system.

LCD Keypad:

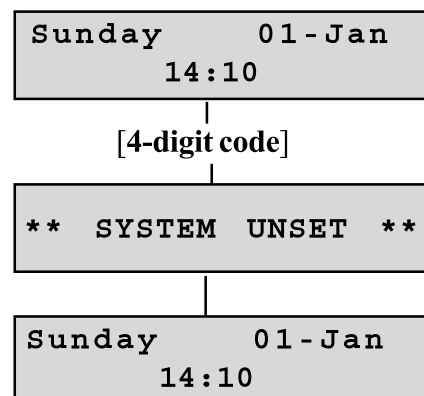
- Enter the premises by the agreed entry route. The system produces an entry tone. The  LED is on and the  LED is off, indicating that the system is set.
- Enter your 4-digit code (**0123** default).
- The system unsets with a double beep. The  LED comes on, indicating that the system is unset.
- After 30 seconds the system displays the date and time.



LED Keypad:

- Enter the premises by the agreed entry route. The system produces an entry tone. The  LED is on and the  LED is off, indicating that the system is set.
- Enter your 4-digit code (**0123** by default).
- The system unsets with a double beep. The  LED comes on indicating that the system is unset.

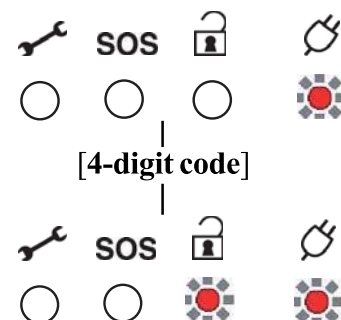

If any Zone,  (Tamper) or **SOS** (Attack) LED's come on then an alarm has occurred, and an intrusion may have taken place. Seek assistance before investigating further as intruders may still be on the premises. Then reset the system.



When you enter your premises you have a short period of time, usually 30 seconds, to enter your code. If you fail to do this the system goes into alarm. Enter your code to stop the alarm.

How to Part Set the System

If your installer has programmed your system for **part set** operation you can set certain zones of the system while others remain unset. Part set operation is often used at night time, and it permits you to freely walk around the bedrooms while the living area and outside doors are protected. Your system may have 2 part-set programs called Program 2 and Program 3.

Before part-setting the system you should ensure that all doors and windows are closed. Ensure that pets do not have access to the protected areas. Your installer may have instructed you to use a different keypad to the one normally used to set the system.

LCD Keypad:

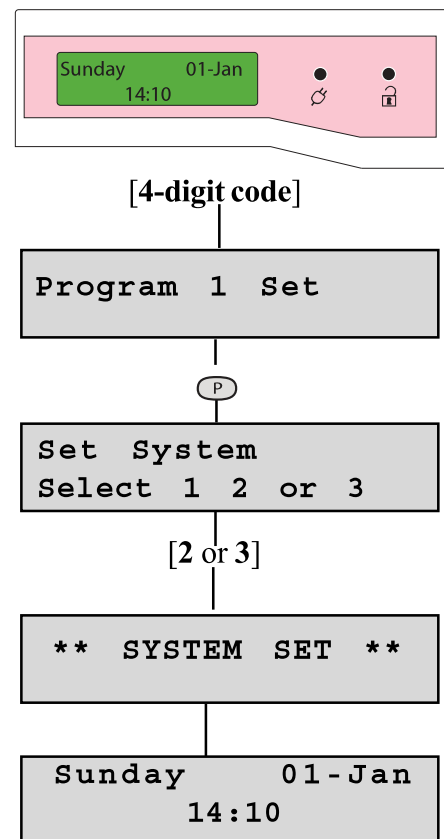

- The  LED should be on. The screen shows the date and time:
- Enter your code [0][1][2][3]. The exit beep starts.
- Press . The exit tone stops.
- Select part-set program [2] or [3]. The system set after a short time. The  LED goes out.

NOTE: There are no exit beeps if **Silent Timed** exit mode has been programmed.



LED Keypad:

The  LED should be on.

- Enter your code [0][1][2][3]. The exit beep starts.
- Press the  key. The exit tone stops and the zone LED's 1 to 3 come on.
- Select part-set program [2] or [3]. The system sets after a short time. The  LED goes out.

NOTE: There are no exit beeps if **Silent Timed** exit mode has been programmed.

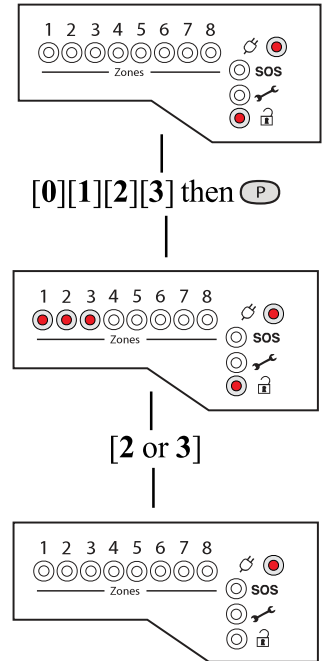

How to Silence an Alarm and Reset the System

If your system goes into alarm then be aware that intruders may be in the premises. Seek assistance before investigating the cause of the alarm.

LCD Keypad:

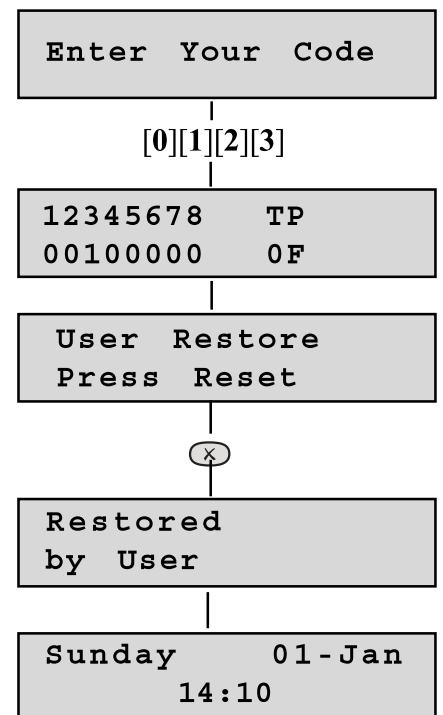

- Enter your code [0][1][2][3]. The alarm stops.
- The screen alternates, showing what caused the alarm and prompting for user reset.
When two or more alarms have occurred, the first alarm has an **F** below the zone number, **Tamper** or **PA**. Subsequent alarms will have a **1** indicating where the alarm has taken place.
- Press . The system resets and displays the date and time if there are no open Tamper, PA or Fire zones to cause a fault lockout.
The system can be reset by the user only if the installer has programmed it to do so. If the message **Engineer Restore Required** appears on screen then the user must contact the installer.
- After 30 seconds the system displays the date and time.



LED Keypad:

- Enter your code [0][1][2][3].
The alarm stops, and the **Zone**,  or **SOS** LED's come on to show the cause of the alarm.

NOTE: When 2 or more LED's are on, the flashing indicator shows the first alarm, and the steady indicators show the second and subsequent alarms.

- Press  .
- If the **Zone**,  or **SOS** LED's go out and the  LED comes on then the system has been reset.
If any of the LED's continue to flash then the system has been programmed to be reset by the installer. In this case you must call the installer to reset the system.
If all LED's light steady (not flashing), and the keypad stops working, then the system has entered a fault-lockout. You must call the installer to rectify this fault.

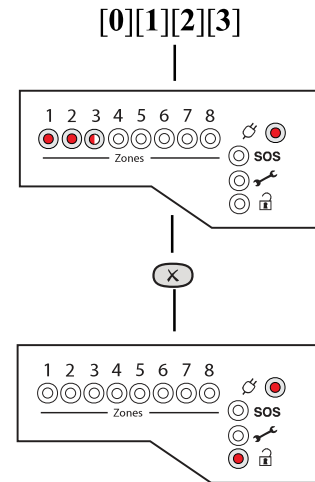



How to Omit Zones

If you cannot set the alarm system because a detector is faulty and in constant alarm you may need to omit its zone from the alarm system. A zone which has been omitted cannot cause an alarm. Omitted zones will be restored after the system is unset.

Before a zone can be omitted it has to be enabled by the installer as a **Used Zone** and as an **Omit Allow** zone.



LCD Keypad:

- Enter your [4-digit code] to start the exit procedure (for more information see **How to Set the System**).
- Press  and the exit beep tone stops, and the first used zone that can be omitted appears on the display.
- Press the zone [number] or  to be omitted.
The display now shows the zone as omitted. If a long reject tone is heard, then the zone cannot be omitted.
- Press  or allow the system to continue to set.

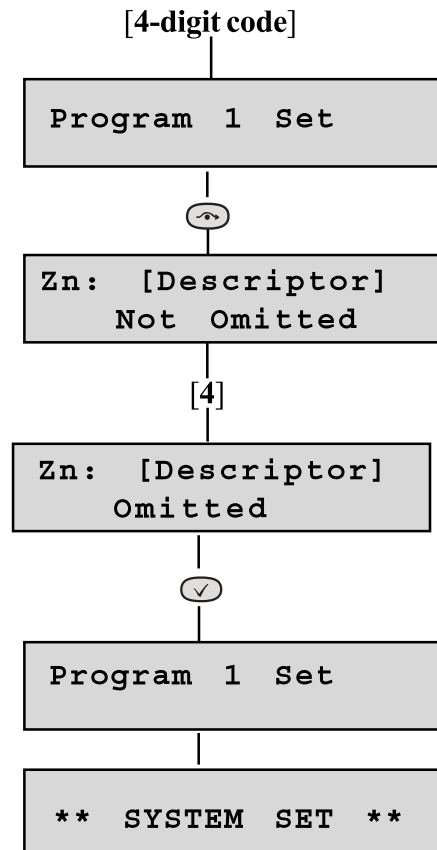
NOTE: Zn = Zone number



LED Keypad:

- Enter your [4-digit code] to start the exit procedure (for more information see **How to Set the System**).
- Press  and the exit beep tone stops, and all LEDs for used zones that can be omitted come on.
- Press the zone [number] to be omitted. The LED now flashes to show the zone as omitted. If a flat reject tone is heard, then the zone cannot be omitted.
- Press  or allow the system to set.

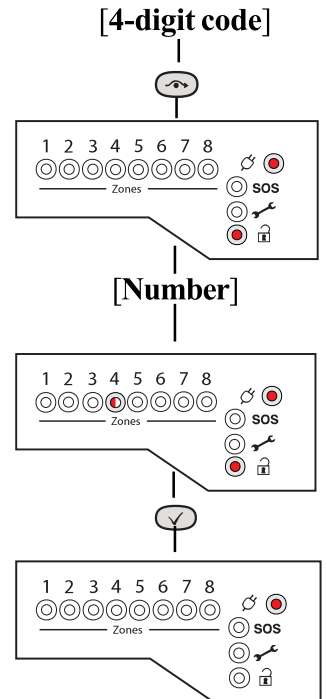

How to Quick Set the System

When you set the system you usually have about 30 seconds to exit the premises. This also means that you need to wait 30 seconds for the system to set. You can reduce this time to just five seconds by carrying out a **Quick Set**.

- Enter your [4-digit code] to start the exit procedure. The exit beep tone starts. (For more information see **How to Set the System**).
- Press  to Quick Set the system and the exit beep tone changes to a more rapid tone. The system sets in five seconds, and the exit tone stops.

Single Key Setting



If enabled by the engineer, the setting process can be started by pressing Set, rather than entering a user code.

How to Set Up Chime Mode

Chime is a low security facility for use when the system is unset. It is particularly useful in a shop to warn of customers presence, or in a house to warn when a back door has been opened. When a Chime zone detects movement the system produces a brief two-tone sound, and the Zone LED comes on.

To set any zone to Chime.



LCD Keypad:

- The  LED is on, indicating that the system is unset.
- Press . The screen shows the first zone that is already set up for Chime (possibly none).
- Press the zone **[number]** to toggle it in and out of chime.
- When you have finished using the Chime mode press  or wait a few seconds for the display screen to the date and time.

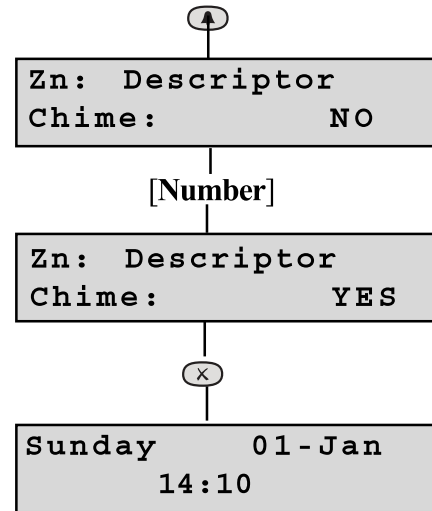
NOTE: Zn = Zone number



LED Keypad:

- The  LED is on, indicating that the system is unset.
- Press . The zone LEDs come on to show those zones that are already set up for Chime (possibly none).
- Press the zone **[number]** to toggle it in and out of chime.
- When you have finished using the Chime mode press  or wait a few seconds. The zone LED goes off.

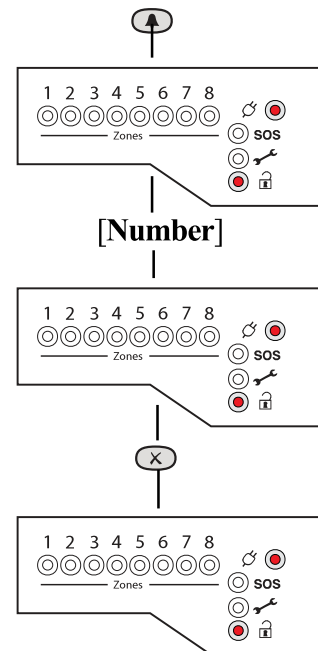

How to Change the Language

This option allows you to display the screen information in one of the following languages: English, French, Italian, Spanish, German, Dutch and Portuguese.

LCD Keypad:

To change the display language:

- Press **P**, then enter your code [0][1][2][3]. The **LED** goes out, indicating that you are in Programming mode. The first menu, Walk Test, appears on the screen.
- Press [5] on the keypad to enter the language configuration menu.
- Press [5] or **✓** to display the current language.
- Press **▲** to scroll through the languages.
- Press **✓** then **✕** to save programming and leave the menu, or to cancel the change press **✕** twice.

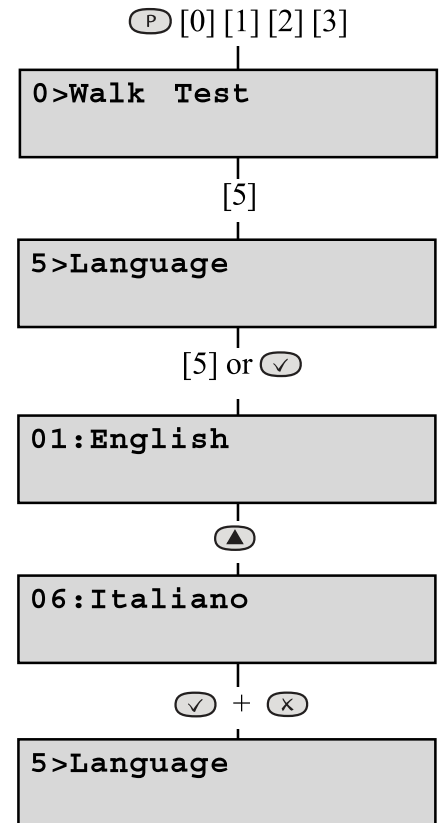

LED Keypad:



The language cannot be changed with the LED keypad.

Changing Codes Using User 1

You should change your code regularly to prevent potential intruders from knowing your code. All codes are 4-digits. The factory set code is [0][1][2][3]. User code 1 can only be changed by user 1.



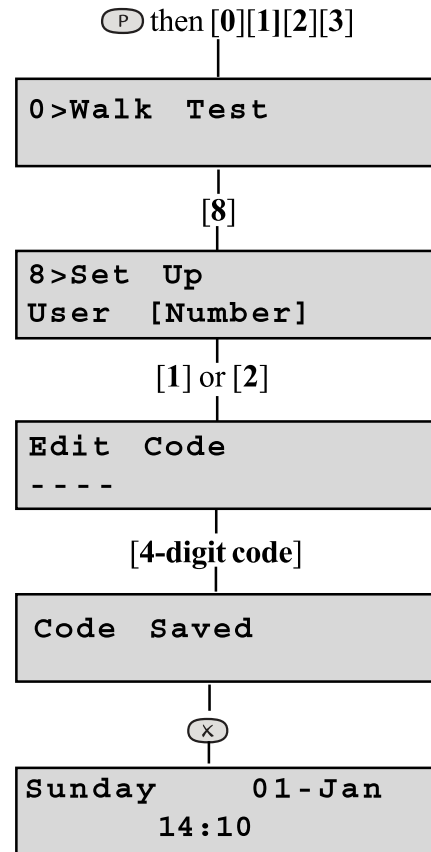

To change user code:

LCD Keypad:

- Press **P** and then enter your code [0][1][2][3]. The  LED goes off to indicate that you are in Programming mode. The first menu **Walk Test** appears on the screen.
- Press **[8]** on the keypad to enter User Set-Up.
- Press **[1]** or **[2]** on the keypad to edit the required user.
- Enter the new **[4-digit code]**. If the code is accepted the system produces a double beep. If it is rejected the code may already be in use and the system produce a long tone. You must choose a different 4-digit code.
- Upon the last keypress the code is saved.
- Press **X** twice to exit Programming mode. The  LED comes on and the screen displays the date and time.



LED Keypad:

- Press **P** and then enter your code [0][1][2][3]. The  LED comes on and the  LED goes off to indicate that you are in Programming mode.
- Press **[8]** on the keypad. LED's 1 and 2 are on to indicate that you have two options, user 1 and user 2.
- Press **[1]** or **[2]** on the keypad to edit the required user. LED's 1-4 are on.
- Enter the new **[4-digit code]**. If the code is accepted the system produces a double beep. If it is rejected the code may already be in use and the system produces a long tone. You must choose a different 4-digit code.
- Upon the last keypress the code is saved. LED's 1-4 are off.
- Press **X** twice to exit Programming mode. The  LED comes on and the  goes off.

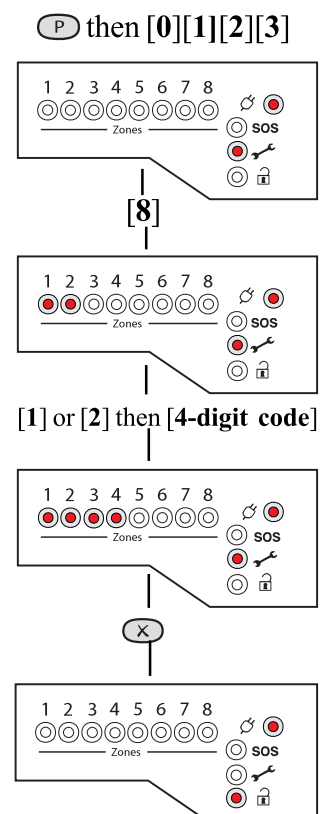

Changing Codes Using User 2

Your alarm system can have a second user code. You may find it useful to set up user code 2 for use by a neighbour for use when you are on holiday. User code 2 operates like user code 1, but it cannot be used to change or delete user code 1.

To change user code 2:

LCD Keypad:

- Press **(P)** and then enter user 2 **[4-digit code]**. The **(P)** LED goes off to indicate that you are in Programming mode. The first menu **Walk Test** appears on the screen.
- Press **[8]** to edit user 2.
- Enter the new **[4-digit code]**. If the code is accepted the system produces a double beep. If it is rejected the code may already be in use and the system produces a long tone. You must choose a different 4-digit code.
- Upon the last keypress the code is saved.
- Press **(X)** twice to exit Programming mode. The **(P)** LED comes on and the screen shows the date and time.

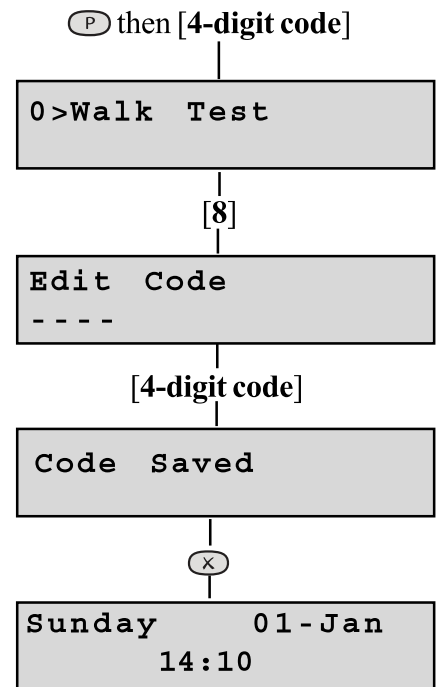

LED Keypad:

- Press **(P)** and then enter user 2 **[4-digit code]**. The **(P)** LED comes on and the **(P)** LED goes off to indicate that you are in Programming mode.
- Press the **[8]** to edit user 2. LED's 1-4 are on.
- Enter the new **[4-digit code]**. If the code is accepted the system produces a double beep. If it is rejected the code may already be in use and the system will produce a flat tone. You must choose a different 4-digit code.
- Upon the last keypress the code is saved. LED's 1-4 are off.
- Press **(X)** twice to exit Programming mode. The **(P)** LED comes on and the **(P)** goes off.

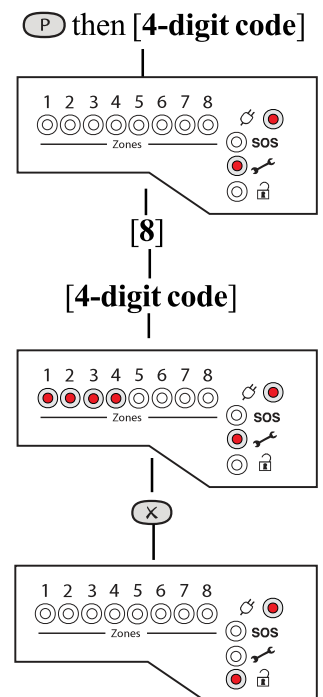

How to Delete User Code 2

You can delete the second code to prevent it being used. User 1 or user 2 can delete user code 2.

To delete user code 2 using user code 1

LCD Keypad:

- Press **P** and then enter your code **[0][1][2][3]**. The **LED** goes off to indicate that you are in Programming mode. The first menu **Walk Test** appears on the screen.
- Press **[8]** on the keypad to enter User Set-Up.
- Press **[2]** to edit user code 2.
- Press **↔** to delete user code 2.
- The message **Code Deleted** is displayed on the screen.
- Press **X** twice to exit Programming mode. The **LED** comes on and the screen displays the date and time.

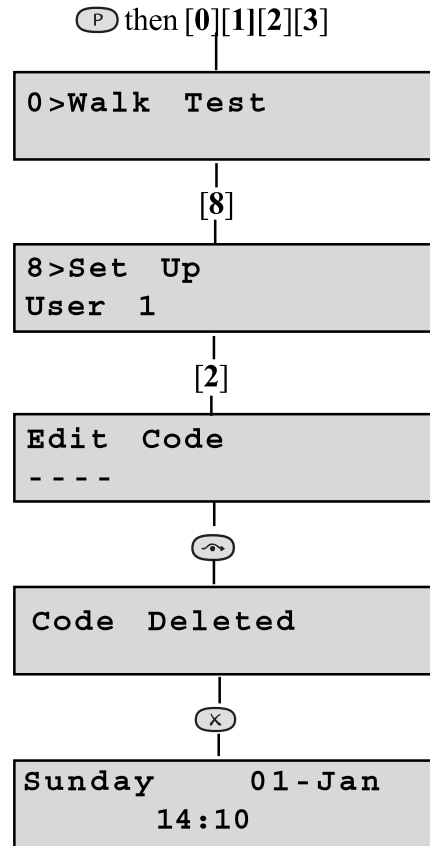

LED Keypad:

- Press **P** and then enter your code **[0][1][2][3]**. The **LED** goes off to indicate that you are in Programming mode.
- Press **[8]** on the keypad to enter User Set-Up. LED's 1 and 2 are on.
- Press **[2]** to edit user code 2. LED's 1-4 are on.
- Press **↔** to delete user code 2.
- User code 2 is deleted. LED's 1-4 are off.
- Press **X** twice to exit Programming mode. The **LED** comes on and the **LED** goes off.

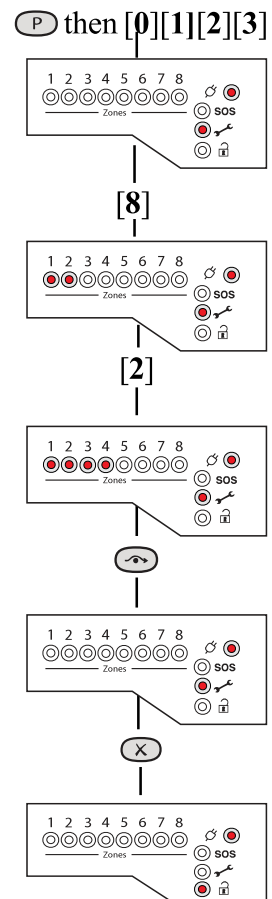

To delete user code 2 using user code 2

LCD Keypad:

- Press **P** and then enter the user 2 [4-digit code].
The **Ⓜ** LED goes off to indicate that you are in Programming mode. The first menu **Walk Test** appears on the screen.
- Press **[8]** on the keypad to edit user code 2.
- Press **↵** to delete user code 2.
- The message **Code Deleted** is displayed on the screen.
- Press **ⓧ** twice to exit Programming mode. The **Ⓜ** LED comes on and the screen displays the date and time.

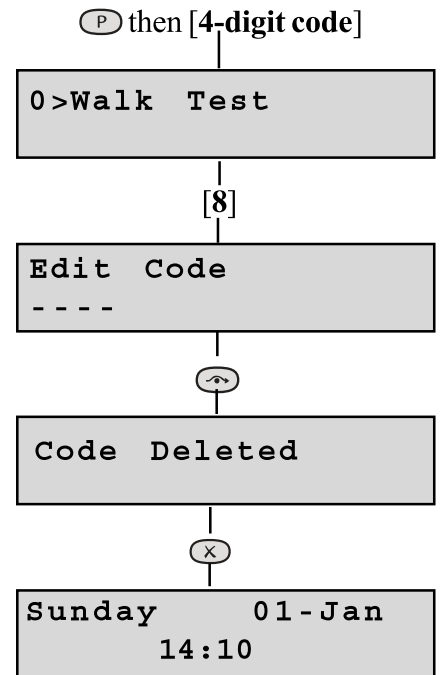

LED Keypad:

- Press **P** and then enter the user 2 [4-digit code]. The **Ⓜ** LED goes off to indicate that you are in Programming mode.
- Press **[8]** on the keypad to edit user code 2. LED's 1-4 are on.
- Press **↵** to delete user code 2.
- User code 2 is deleted. LED's 1-4 are off.
- Press **ⓧ** twice to exit Programming mode. The **Ⓜ** LED comes on and the **🔧** LED goes off.

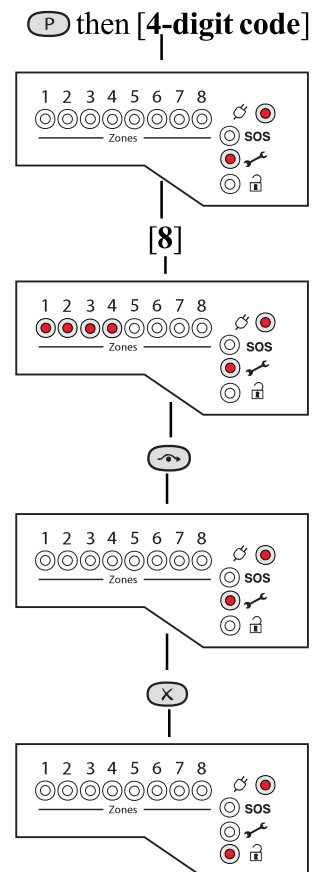

Duress Code

Your alarm system can have a duress code. The Duress code is used in a hold-up situation where there is pressure to set or unset the system. The Duress code operates like your normal code but in addition it silently sends a signal to the Alarm Receiving Centre. The operator at the ARC may request the Police to attend your premises.

The duress code can only set up, edited and deleted by the installer while in *Engineer program mode*.

NOTE: The Duress code facility is not applicable to the Optima Compact system.

How to View the Event Log

1 = LCD Keypad:

The event log gives a display of all the events that have taken place. The events are arranged by date and time. Up to 250 events can be stored in the memory. When the log reaches 250 events and another event takes place, the oldest event drops out.

To view the event log:



- Press (P) and then enter your code [0][1][2][3]. The (LED) goes off to indicate that you are in Programming mode. The first menu **Walk Test** appears on the screen.
- Press (▲).
- Choose [1] for Event Log in LCD screen.
- The last event (250) appears on LCD screen. To go forward through the event log in sequence, press (▶). To go back through the event log in sequence, press (▲).
- Press (X) twice to leave the menu.



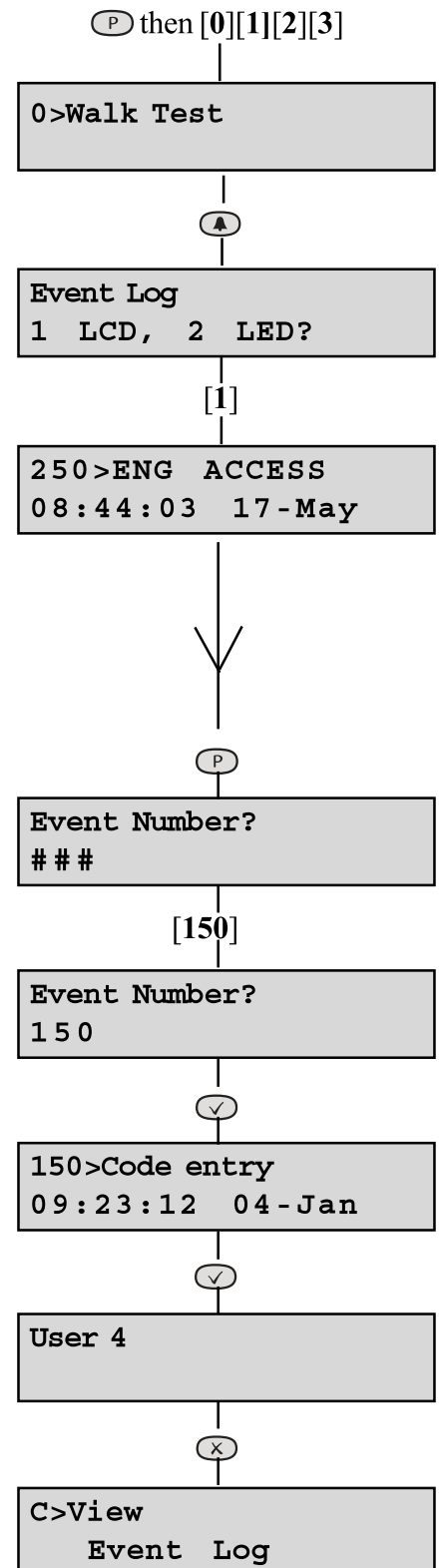



To go to a specific event:

- Press (P).
- Key in the Event Number you want to see (eg 150).
- Press (✓). The event appears on the LCD screen.
- Press (✓) again to see further details of the event.
- Press (X) twice to leave the menu option.



2 = LED Keypad:

The LED keypad is limited to show the last eight set periods with the eighth being the oldest. **Zone**, **SOS** and  LEDs are on, to show zone in alarm. A flashing LED indicates the first zone in alarm.  indicates the status of the panel at the time of the alarm.

- Press  and then enter your code **[0][1][2][3]**. The  LED goes off and the  LED comes on to indicate that you are in Programming mode.
- Press  to enter into Event Log menu. LED's 1 and 2 are on.
- Press **[2]** for LED keypad. The first zone to activate is indicated by a flashing LED.
- Press **[1 to 8]** for the desired event or  to go through events in sequence.
- Press  twice to leave the menu.

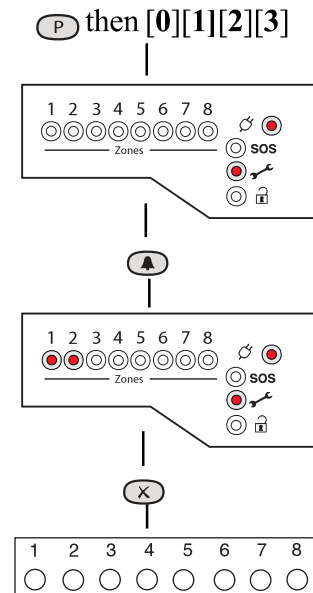

How to Test Your Alarm system

You should check that your alarm system still works correctly by periodically carrying out the alarm system tests described here.

How to Test the Bell, Strobe and Internal Sounder

This function tests the alarm function of the Bell, Strobe or Internal Sounder. Pressing the appropriate key. **[1-3]** toggle the function ON or OFF. Using the  also selects the appropriate alarm function.

Pressing **[0]** turns all alarm outputs to OFF.

Pressing  toggles the selected alarm output.

Pressing  turns off all outputs and leaves the function.

The outputs are:

1 = Bell, 2 = Strobe, 3 = Sounder

NOTE: To test the Low volume sounder enable option 3 only. To test for a high volume sounder enable both options 2 and 3 together.

LCD Keypad:

- Press **P** and then enter your code **[0][1][2][3]**. The **LED** goes off to indicate that you are in Programming mode. The first menu, **Walk Test** appears on the screen.
- Press **▲** for menu **Alarm Test**.
- Press **[1]** or **✓** to enter into first function ON or OFF.
- Press the **▲** or number **[2]** or **[3]** for the other functions.
- Press **✕** to leave the menu.

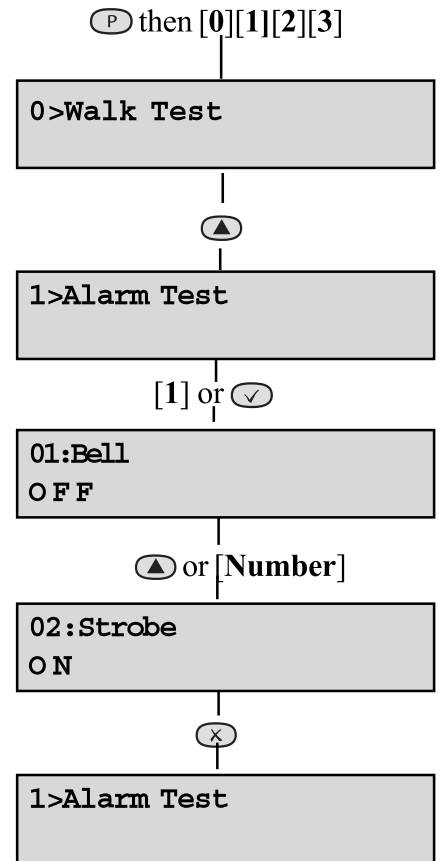

LED keypad

- Press **P** and then enter your code **[0][1][2][3]**. The **LED** goes off and the **LED** comes on to indicate that you are in Programming mode.
- Press **[1]** for menu **Alarm Test**.
- Press **[1]** or **✓** to toggle first function ON or OFF.
- Press number **[2]** and **[3]** for the other functions.
- Press **✕** twice to exit Programming mode. The **LED** comes on and the **LED** goes off.

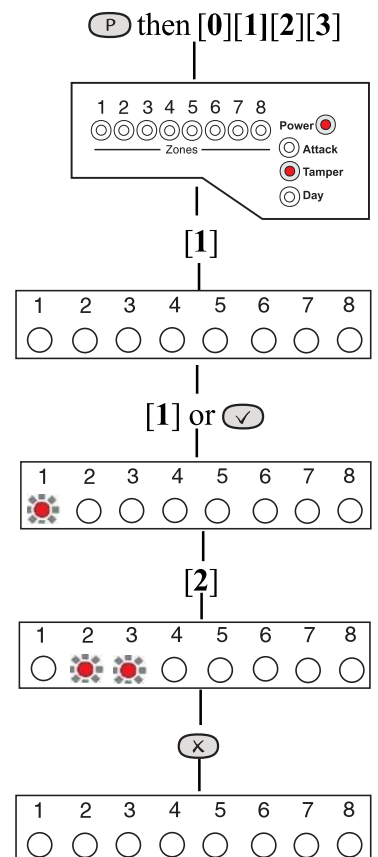

How to do a Walk Test

Walk around your property, and in turn cause each detector to go into alarm. Also, open and close all door and windows that are protected by the system. For each detector (including door or window sensor) that is activated the system produces a series of beeps, and the associated zone is indicated on the keypad.

NOTE: Do not test any **Personal Attack, Fire or Tamper** keys during the Walk Test since these are still active and will cause a full alarm.

If any of the tests fail, or you are unsure of the correct procedure, contact your installer

LCD Keypad:

- Press **P** and then enter your code **[0][1][2][3]**. The **LED** goes off to indicate that you are in Programming mode. The first menu **Walk Test** appears on the screen.
- Press **✓** or **[0]**. Zones 1-8 have a zero (0) below each number.
- When a zone is successfully tested, number 1 replaces the 0. Zones are added to the list as each one is activated.
- Press **X** to leave the menu or **✓** to restart the Walk Test.

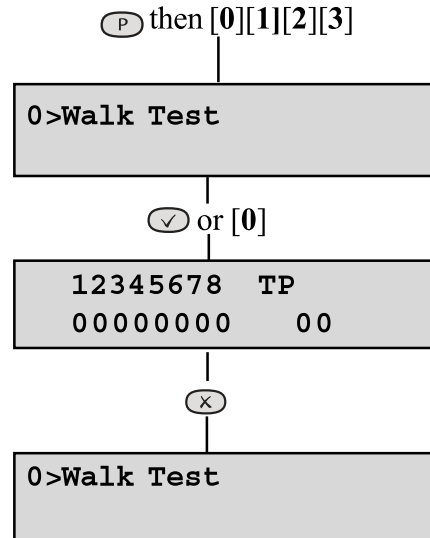

LED keypad

- Press **P** and then enter your code **[0][1][2][3]**. The **LED** goes off and the **LED** comes on to indicate that you are in Programming mode, **Walk Test**.
- Press **✓** or **[0]**. Zones 1-8 are off.
- When a zone is successfully tested, the LED is on. Zones are added to list as each one is activated.
- Press **X** to leave the menu or **✓** to restart the Walk Test.

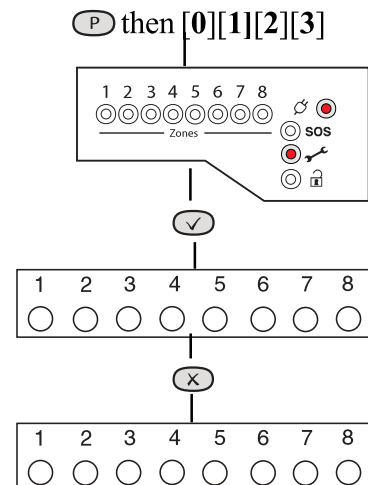

How to Set up the Time and Date

LCD Keypad:

- Press **P** and then enter your code **[0][1][2][3]**. The **LED** goes off, indicating that you are in Programming mode. The first menu **Walk Test** appears on the screen.
- Press **[4]** and the **Time and Date** Screen appears.
- The **Time** can be modified in hours, minutes and seconds in the format **HH:MM:SS**. The number keys on the keypad 0-9 are used for this function. As each digit is modified the cursor moves to the next one. When the time is correct press **✓** to accept the change and move to the next screen or to cancel the change press **✕** twice.
- The **Date** can be changed in day , month, year format **DD-MM-YY**. The number keys on the keypad 0-9 are used for this function. As each digit is modified the cursor moves to the next one. When the date is correct press **✓** to accept the change or to cancel the change press **✕** twice.

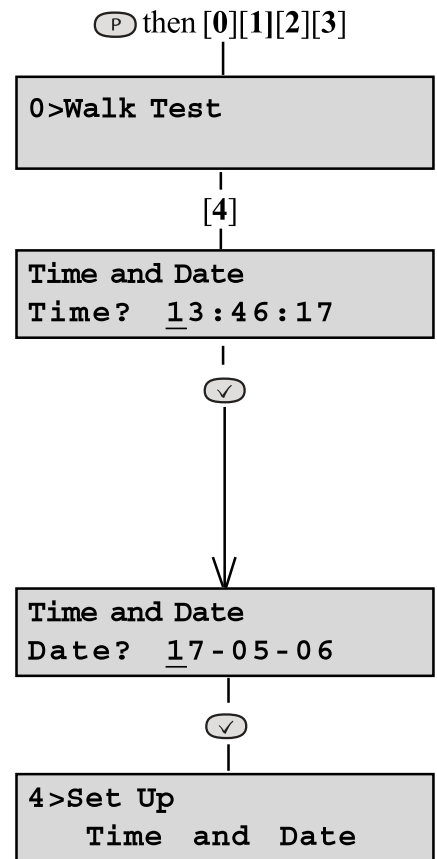

LED Keypad:

If required, the time and date can be entered as per the procedure for the LCD keypad. However no information will be indicated on the LED keypad. The only indication on the LED keypad that you are in menu 4, **Set up Time and Date**, is that LED's 1 to 6 on the LED Keypad will be ON.

External Siren Time: _____

Siren delay: _____

Area Protected		Zone Name	Program 1	Program 2	Program 3
Zone 1					
Zone 2					
Zone 3					
Zone 4					
Zone 5					
Zone 6					
Zone 7					
Zone 8					

T = Timed (Entry/Exit Zone)

TI = Time Inhibited (Access zone to keypad)

I = Immediate



The panels conform to the requirements of the European EMC and Low Voltage directives, and carry the CE mark